



We have all the static control products you will need to outfit your static safe environments and Cleanroom Areas

You will see that we will have many opportunities for innovative new products, including a wider offering of static control and cleanroom products..

## OUR ESD PRODUCT OFFERING

- ESD Flooring
- ESD Workstations
- Personnel Grounding
- ESD Garments
- ESD Table Mats
- Cleanroom Wipes
- Cleanroom Garments
- ESD Packaging Materials
- ESD Handling and Storage
- ESD Foams
- ESD Test and Measurement
- ESD Brushes
- Cleanroom Accessories
- Kapton tapes
- ESD Paper
- ESD Office Equipment
- ESD Service Equipment
- ESD Tapes
- ESD Gloves
- Cleanroom Masks
- ESD Shoes

### We Aim for the following:

- Customer Satisfaction
- Quality Products
- Very Competitive Pricing
- Innovation
- Highly Motivated and Specialist Team
- Long Term Relationships with Customers
- Maximum Availability
- Respect Delivery Terms

## METAL-IN & METAL OUT SHIELD BAGS



### Product Information

- Provides 'Faraday Cage' protection against ESD
- Conforms to MIL-PRF-81705D Type III, EIA 625, EIA 541
- Can be heat sealed
- Semi transparent finish
- OPEN TOP & ZIP TOP Available in 66 Standard Sizes
- **60my , 75my and 100my Thickness available**
- Shield Film Rolls available on request

Custom sizes and printing available on request

## MOISTURE BARRIER BAGS



### Product Information

- Shielding & Moisture Protection
- 96 my & 150my & 180my
- 140my available on request
- Can be vacuum sealed for dry packaging applications
- Opaque
- Custom sizes available on request
- EMI Shielding - Meets requirements of MIL-PRF-81705D Type 1
- 20 Standard Sizes Available / Custom Made on request

**Related Products – HIC Cards, Dessicant**

## PINK BAGS & PINK BUBBLE

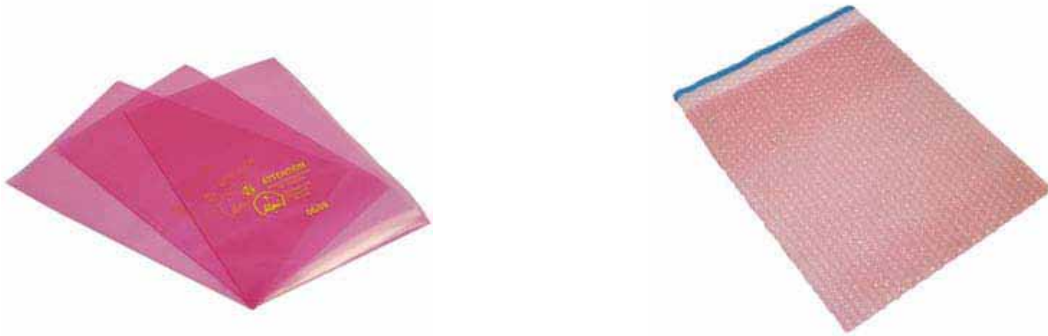

### Product Information

- For packaging non ESD items within an ESD protected area
- 50my, 60my or 80my Thickness Available
- Bags Open Top & Zip Top
- Pink Tubing , Bubble Rolls Available
- Can be heat sealed
- Low cost

## ESD KAPTON® & KAPTON® DOTS



### Product Information

- DuPont® material
- High temperature resistance (250°C – 400°C)
- Low residue
- 33m length, width from 1mm to 500mm
- Custom sizes available on request
- Kapton® Dots many sizes available
- Custom shapes and backing options available on request

## ANTISTATIC TAPE & HEAT RESISTANT



### Product Information

- Antistatic Transparent Tape & Heat Resistant Tapes
- High temperature resistance
- Used for Circuit Boards, Laptops and Packaging
- 33m & 66m lengths, width from 2mm to 500mm
- Custom sizes available on request
- Packaged Individually

## ESD YELLOW ADHESIVE TAPES

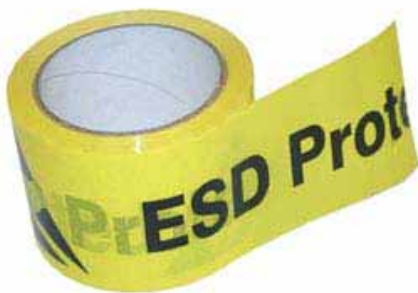

### Product Information

- Adheres well to most surfaces
- Yellow Adhesive Floor Tape & Yellow Warning Tape
- Highly visible
- ESD logo as per EN 61340-5-1
- 75mm width x 33m length Floor Tape
- 50mm width x 66m length Packaging Tape

# FLOOR ADHESIVE TAPES



## Product Information

- Adheres well to most surfaces
- Highly visible
- Hazard Warning Tapes in Green/White & Black/Yellow & Red/White
- Floor Tapes in Blue, Green, Red, Black, Yellow, White
- Aggressive pressure sensitive adhesive
- Sizes 50mm x 18m
- Custom widths available on request

## Related Items: FLOOR TAPE APPLICATOR



## CONDUCTIVE BRUSHES



### Product Information

- Conductive handle with conductive nylon bristles
- Suitable for cleaning PCB's
- Resistivity  $10^4$  to  $10^6$  Ohms
- Suitable for both abrasion and residue removal
- 12 types Available

## SPLICE TAPES & SPLICE TOOLS



### Product Information

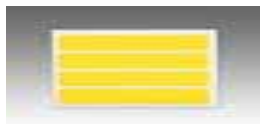
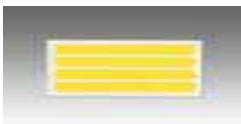

- For Use with All Major SMT Pick & Place Feeders
- Single Splice Tapes & Double Splice Tapes
- Fuji \* Samsung \* Panasonic \* Mydata \* Yamaha \* Siemens \* Juki \* Sanyo \* Universal \* Philips \* Hover-Davis \* Quad \* Tyco
- Increase throughput and yields by 15-20%



## ESD CHAIRS



### Product Information

- New range of ESD safe chairs designed specifically to suit the demands of the electronics industry
- Fully adjustable back and height
- These chairs are available with or without castors
- Foot Rings Available, ESD Castors Available, Arm Rests Available

## TWEEZERS



### Product Information

- New Range of Stainless Steel Tweezers ST & SA Type
- New Range of Black Conductive Plastic tweezers
- Made of Special Carbon Fiber suitable for Cleanroom Class 100
- Many Applications and Industries

## ESD MATTING

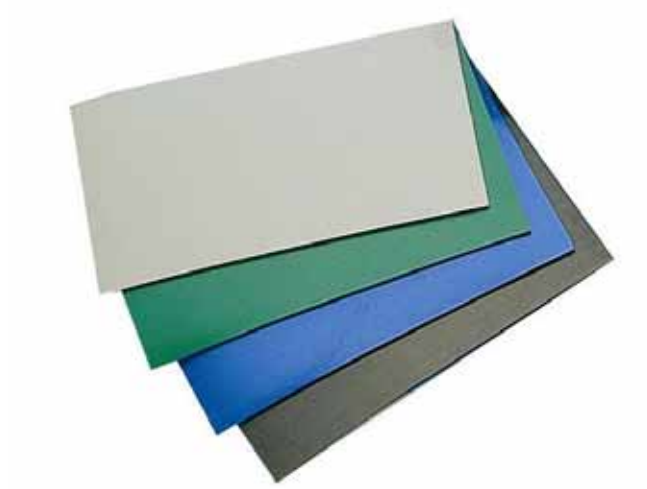

### Product Information

- 2mm & 3mm thick static dissipative matting
- Excellent heat / chemical resistance and dissipative surface resistivity
- Available in a selection of colours from stock and can be cut to size
- Sizes 0.6m x 10m, 1m x 10m, 1,2m x 10m
- Black Conductive matting available in same sizes
- Cut mats available on request

## WRIST BAND & COIL CORD SETS



### Product Information

- Comfortable, fully adjustable wrist band a 10mm press stud
- Supplied complete with a PU Coil Cord 1.8m or 2.4m
- 10mm press stud termination
- Anti-Allergic Wrist Band SETS Available
- Dual Wire Wrist Band SETS Available
- Disposable Wrist Band Available
- Metal Wrist Band SETS Available in Black

## ESD GLOVES TOP FIT & PALM FIT



### Product Information

- Our range of ESD gloves are made from Polyester and Nylon which offers good elasticity and excellent performance
- Ideal for electronic production, clean areas, optical electronics, and aerospace environments
- **ESD White Top Fit - ESD White Palm Fit**
- **ESD Grey Carbon Top Fit – ESD Grey Copper Top Fit**
- **ESD Grey Carbon Palm Fit – ESD Grey Copper Palm Fit**

## ESD GLOVES STRIPED & DOTTED



### Product Information

- PVC dotted palm with non-slip properties
- Striped Glove 100% Polyester
- Good elasticity
- Excellent sweat absorbency
- Washable
- Good ventilation
- Delicate round tip finishing
- Surface resistivity: 10E6 /ohms
- Micro-electronics / Assembly / Packing

# STICKY MATTS & STICKY ROLLERS

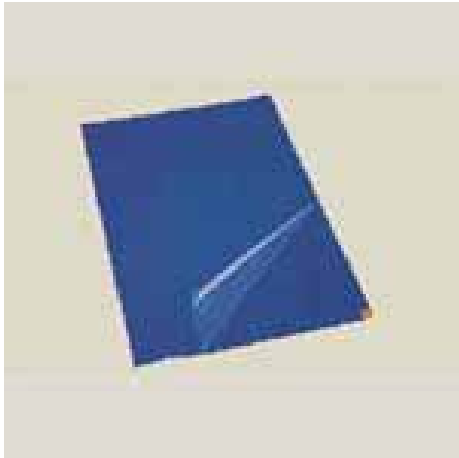

## Product Information

### Sticky Mat Features:

- Material: low density polyethylene
- Suitable for clean room use
- **30 Layers & 60 Layers Available in BLUE & WHITE**

### Sticky Matt Frame Features:

- Polyboard rigid frame to inset multi layer tacky mats
- 6mm thick with bevelled edges
- Suitable for wood, carpet and porous surfaces to ensure mats stay

### Sticky Rollers:

- **Designed to remove dust from surface**
- **Different sizes available**

# POSCA MARKERS



## Product Information

- A unique water based pigment ink
- **PC1M, PC3M, PC5M, PC8K, PC17K**
- Used on Most Surfaces
- Fade/waterproof performance
- 2+ years shelf life
- RoHS Compliant



## STENCIL ROLL WIPERS



### Product Information

- Compatible in class 10 environments
- Ultralow particle generation
- Ultralow extractable level
- Ultralow metallic ion content
- Super high absorbency
- Super high durability
- Versatile in a wide range of wiping applications
- Cleanroom laundered and packaged
- Certified quality control with lot-to-lot traceability
- **DEK,FUJI,MPM,EKRA,SANYO,PANASONIC,JUKI,KME**

## PCB MAGAZINE RACKS

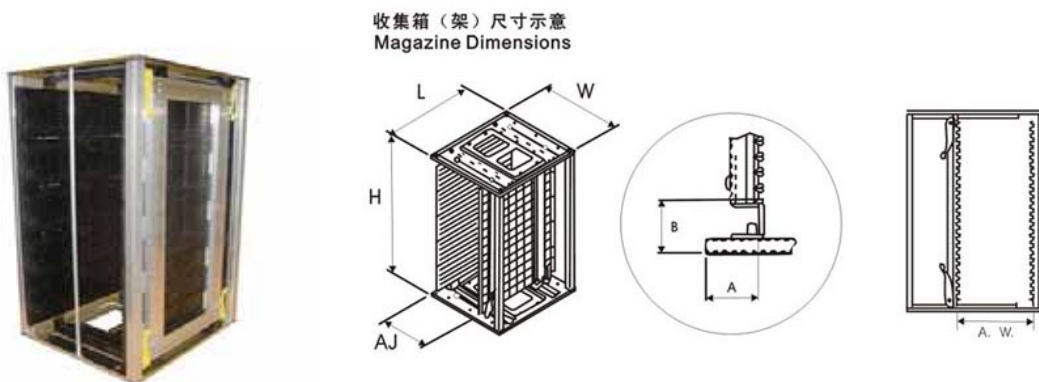

### Product Information

- SMT magazine racks are designed for the manufacture, assembly, storage and transfer of PCB
- Gear adjustment
- Common type (60DegreeC) and heat resistant type (120DegreeC,160-200DegreeC) are available
- Surface Resistance: 10<sup>4</sup> - 10<sup>6</sup> Ohms

## HIC CARDS & DESSICANT



### Product Information

- HIC CARDS for Moisture Barrier Bags
- 3 Spot, 4 Spot, 6 Spot, JEDEC, Packed in Tins
- Dessicant Activated Clay or Silica Gel
- In Paper, Non-Woven and Tyvek Materials
- From 1g to 25kg Bags available
- Any size made on request

## ESD & CLEANROOM GARMENTS



### Product Information

- Manufactured for use in ESD & Cleanroom protected areas
- 65% polyester, 33% cotton and 2% Conductive Fibre,
- 96% polyester, 4% Conductive Fibre
- 96% Cotton, 4% Conductive Fibre
- They are lightweight and comfortable have the ESD symbol
- **Lab Coats, Jackets, T-Shirts, Polo Shirts, Trousers, ESD Winter Jacket**
- Logo on Request Hot Stamp or Embroidery
- Sizes from S, M, L, XL, XXL, XXXL
- **5mm Stripe, 5mm Grid, 2.5mm Grid, also Fabric in Rolls**

- Machine washable up to 60°C
- Cleanroom Garments & Booties made on request
- Class 1000 to 10 000
- Colors **WHITE,BLUE,PINK,YELLOW,BLACK,BEIGE,GREEN,RED**
- Any color made on request

## PERSONNEL GROUNDERS



### Product Information

- Hardwearing Grounders designed to ensure long term ESD protection to all personnel
- Heel Grounders 1 Meg ,Economy, Snap Lock, Clip On Available
- Toe Grounders 1 Meg
- Sole Grounders in S,M,L,XL sizes
- Disposable Heel Grounders for Visitors

## ESD DISPOSABLE SHOE COVERS



### Product Information

- ESD Yellow Disposable Shoe Covers to ensure ESD protection
- Suitable for Shoe Dispensing Machine
- 100pcs per Pack
- Shoe Dispenser also available in ESD Version Aluminum with ESD Symbol

# ESD SOLVENT DISPENSERS



## Product Information

- ESD Solvent Dispensers
- 4oz,6oz,8oz
- Blue or Yellow Color

# TEST INSTRUMENTS



## Product Information

- EU Approved Test Equipment & Calibrated
- 1 year Garuantee
- SRM –Surface Resistance Meter 9 Volt
- Dual Footwear & WristBand Tester
- SRM KIT – Surface Resisitance Mater Kit 100volts with weights
- Single Band & Dual Band Constant Monitors
- Constant Matt Monitor

# WASTE DISPOSAL BINS



## Product Information

Polypropelene Waste Bins

- Made of Black Conductive Polypropylene
- Marked with ESD logo
- 14liters, 35liters, 60liters & 240liters Trolley Bin With Wheels
- Washable
- Rg: <106 ohms

# NSK GREASE FOR SMT



## Product Information

NSK LUBRICATING GREASE FOR SMT

- Used in high speed and medium load application
- Outstanding low dust characteristics
- Stable torque characteristics
- Longer lubrication life
- Superior rust prevention



# CONDUCTIVE TOTE BOXES



## Product Information

### CONDUCTIVE TOTE BOXES

- Made of permanent conductive, carbon loaded Polypropylene
- Colour: black
- Stackable
- Pallet modular size
- With ESD symbol
- Any size made

### Sales and Service Office:



HOANG-PVM GmbH  
Am Gierath 26, 40885 Ratingen  
Tel.: 021 02 / 7407 838  
Fax.: 021 02 / 74 07 871

Email: [hoang-pvm@t-online.de](mailto:hoang-pvm@t-online.de), [info@hoang-pvm-engineering.com](mailto:info@hoang-pvm-engineering.com)

Web: [www.hoang-pvm-engineering.com](http://www.hoang-pvm-engineering.com)